

THIS COPY IS PROVIDED ON A RESTRICTED BASIS AND IS NOT TO BE USED IN ANY WAY DETRIMENTAL TO THE INTERESTS OF PANDUIT CORP.

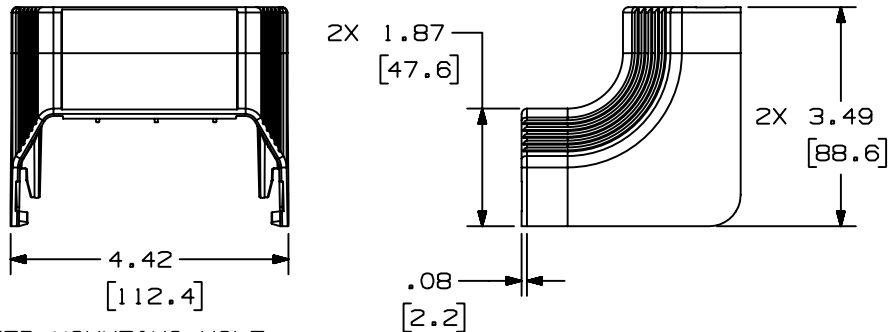

PANDUIT P/N	WEIGHT
T70IC	.418 LB [189.77 g]



- NOTES:
1. SEE CURRENT CATALOG FOR ADDITIONAL PART SUFFIXES TO INDICATE COLOR AND OR PACKAGE QUANTITY,
 2. THIS PRODUCT IS INTENDED TO BE USED WITH PANDUIT TYPE T70 RACEWAY.
 3. DIMENSIONS IN PARENTHESIS ARE IN METRIC.

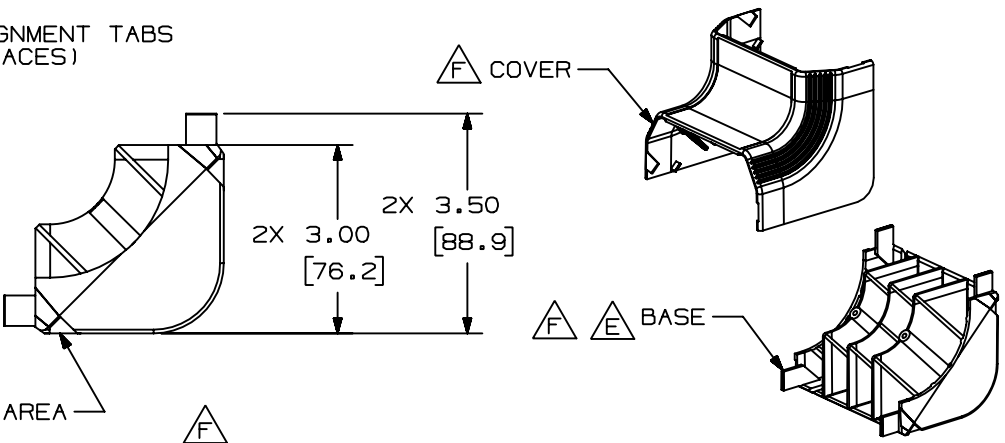
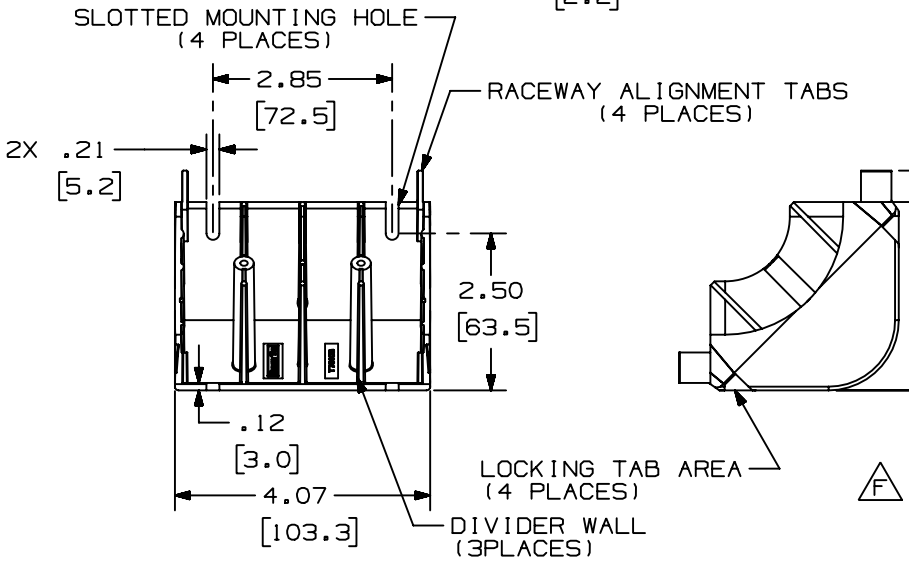

CAD FILENAME/LAYERS D35541BX_DC_T70IC_04A.prt

PANDUIT CORP. TINLEY PARK, ILLINOIS

REV	DATE	BY	CHK	DESCRIPTION	ECN	CHK	CUST	SUP
4	10-28-03	JBN	PM	G. .418 LB (189.77 g) WAS 3.97 LB (1804 g) F. REVISED GEOMETRY	35541-20	RGRO	RGRO	
3	05-13-03	JBN	PM	E. REVISED BASE GEOMETRY	35541-20	RGRO	RGRO	
-	-----	---	---	D. 3.97 LB (1804g) WAS 3.61 LB (1640g)	-----	---	---	
2	12-20-99	MSO	HIW	C. PVC WAS ABS/POLYCARBONATE. B. REVISED DRAWING TITLE.	35541-20	HIW	HIW	
1	12-31-98	DW	HIW	A. DWG WAS REVISED TO ONE SHEET	35541-20	HIW	HIW	
R	09-13-96	JBA	CEF	RELEASED TO PRODUCTION	35541-20	CEF	CEF	

T70 INSIDE CORNER (T70IC)
CUSTOMER DRAWING

UNLESS OTHERWISE SPECIFIED, DIMENSIONAL TOLERANCES ARE:
(.X) ± (.XXX) ± .010 (.3)
(.XX) ± .03 (.8) ANGLES ±

UNLESS OTHERWISE SPECIFIED, ALL DIMENSIONS ARE GIVEN IN INCHES, THIRD ANGLE PROJECTION.

DRAWN BY JBA	MAT'L: PVC	SCALE NONE
DATE 09-13-96		DRAWING NO. 35541-20
CHECKED BY CEF		DWG SIZE A